

# Dental Implant Unit Instruction Manual

Read the instruction manual carefully before operation



## Contents

<b>1 Prefaces</b> .....	1
1.1 Device type.....	1
1.2 Precautions.....	1
<b>2 Product introduction</b> .....	2
2.1 Notice.....	2
2.2 Contraindications and precautions.....	4
2.3 Technical specifications.....	5
2.4 Intended use.....	5
2.5 Structure.....	6
2.6 Safety requirements.....	6
<b>3 Configuration</b> .....	6
3.1 The Foot pedal structure description.....	6
3.2 The host structure description.....	7
3.3 The motor structure description.....	8
<b>4 Installation</b> .....	8
4.1 Safety requirements during installation.....	8
4.2 Accessories connection.....	8
<b>5 Control interface of host and foot pedal</b> .....	12
5.1 The host interface.....	12
5.2 Touch buttons instructions.....	13
5.3 Foot pedal control.....	14
<b>6 Operation</b> .....	15
6.1 Program.....	15
6.2 Factory settings adjustment.....	19
6.3 Water flow adjustment.....	20
6.4 Motor rotation direction adjustment.....	20
6.5 Standard operation.....	20
<b>7 Clean, disinfection, and sterilization</b> .....	20
7.1 Cleaning .....	21
7.2 Disinfection.....	21
7.3 Drying.....	21
7.4 Packaging .....	21
7.5 Sterilization.....	21
<b>8 Error code and solution</b> .....	22
<b>9 Storage, maintenance and transportation</b> .....	23
9.1 Storage.....	23
9.2 Maintenance.....	24
9.3 Transportation.....	24
9.4 Replacement of fuse.....	24
<b>10 Environment protection</b> .....	25
<b>11 Standard symbols</b> .....	25
<b>12 Statements</b> .....	25

## 1 Prefaces

Thank you for purchasing Dental Implant Device. In order to guarantee the correct operation, it is recommended to read this instruction manual carefully before operation.

### 1.1 Device type

- 1) Type of protection against electric shock: Class I equipment with internal power supply.
- 2) Degree of protection against electric shock: B type applied part.
- 3) Recommended disinfection method: See section 7 Cleaning, disinfection, and sterilization.
- 4) Degree of safety application: Equipment cannot be used in the presence of a flammable anesthetic mixture with air, oxygen, or nitrous oxide.
- 5) Operating mode: Continuous operation

### 1.2 Precautions

- 1) Please read these precautions before operation and operate in correct way.
- 2) The following icons is for ensuring safe operation, preventing you or others from being hurt. These icons are classified by degree of risk, degree of damage and severity. All indicators should be highly concerned. Please obey the instruction.



#### Precautions

Indicating instructions to be observed for ensuring safety.



#### Warnings

Indicating potential slight injury or bodily injury.



#### Dangers

Indicating potential personal injury or bodily injury .

## 2 Product introduction

### 2.1 Notice



#### Dangers

- 1) To prevent electric shock, do not use wet hands to pull the power cord; be sure to prevent the control circuit from water; use a grounded electrical outlet.
- 2) Keep it away from explosives and combustibles, with special care not to use this machine for patients who use nitrous oxide anesthesia.



#### Warnings

- 1) In the presence of electromagnetic interference environment, the implanter may be malfunctioning. Do not install the Dental Implanting Device near equipment that releases magnetic waves. When using ultrasonic vibrating equipment or electrode knife nearby, close the switch on the control panel.
- 2) Implanter requires special precautions for EMC and needs to be installed and put into service according to the EMC environment.
- 3) To avoid possible injury to human or damage to the device, make sure that the motor handpiece (after simply referred to as the motor) is completely parked when replacing the implanting tool.
- 4) Device with electromagnetic launcher will affect the normal operation of Implanter, do not run both devices at the same time.
- 5) Implanter cannot be used in operating rooms containing potentially flammable gas mixtures.
- 6) Severe impact, such as dropping, will lead to damage to the implanting device.
- 7) During the work of peristaltic pump, the water pipe cannot be excessive bending or knotting, otherwise the pipe may fracture.
- 8) Do not attempt to disassemble the control panel, foot control or motor.
- 9) When the pump cover is opened, please close the device. Do

not touch the rotating parts of the pump, which may cause injury.  
10) Handpieces should be cleaned, lubricated and disinfected immediately after use.

- 11) Do not lubricate the motor. Lubricating oil can cause overheating, resulting in damage to the motor. The host and pedals cannot be disinfected.
- 12) The motor cable cannot be removed from motor.
- 13) Do not clean the device with dissolving solution.
- 14) Switch off electrical power after each use.



#### Precautions

- 1) Please read this instruction manual before operation and master parts of functions.
- 2) Check the operating status of Implanter before use and confirm that there is no abnormal condition.
- 3) Test the Implanter before operation to ensure correct operation.
- 4) It is recommended to use the original pre-disinfection disposable water pipe combination.
- 5) If the frequency of use is very high, please consider storing some spare parts.
- 6) Please cut off the power before cleaning the control panel with a damp cloth.
- 7) Dispose water pipe after operation with the method of disposing medical waste.
- 8) If you need to repair and purchase spare parts, please contact the authorized supplier. It is forbidden to disassemble or replace the device without permission.
- 9) The accuracy of torque monitoring depends on the accuracy of the handpiece installed on the micro motor. If the handpiece produced by other manufacturers is used, the actual torque value may not be displayed correctly. To ensure that the actual torque matches the displayed torque, please use the matched handpiece.
- 10) If there is a permanent malfunction (excessive vibrations,

noise, heat production, etc.) on the Implanter, please immediately close it and return it to the authorized dealer.

This instruction manual is intended to indicate the safety requirements, installation procedures, proper methods of use and proper maintenance of the equipment. If you encounter any unexpected problems, please contact with the authorized dealer.

The manufacturer will not be responsible for any personal injury or property damage caused by device tampering or modification conducted by unauthorized person.

We reserves the rights to change the design of the equipment, the technique, fittings, instruction manual and the content of the original packing list at any time without further notice. The pictures are only for reference. The final interpretation rights belong to us.

We will continue to update its products, thus bring changes in device components. If there is any difference between your manual and the description on your product, please contact the authorized distributor or after-sales service center of us for explanation.

This manual is strictly prohibited from being used in any way other than installation, use and maintenance of the equipment.

## 2.2 Contraindications and precautions

- 1) The hemophilia patient is forbidden to use this equipment.
- 2) Heart disease patients and children should be cautious to use the equipment.
- 3) The patients and doctors with heart pacemaker are forbidden to use this equipment.
- 4) People with mental disorders should be cautious to use this equipment.
- 5) Patients with allergic constitution and drug allergy history are forbidden to use this equipment.

6) Pregnant women, lactating women, and women have a plan of birth should be cautious to use this equipment.

7) Patients with oral and maxillo-facial infection, oral mucosal diseases, periapical disease, gingivitis, periodontitis, or mouth neoplasm should be cautious to use this equipment.

8) Patients with severe systemic infection or systemic diseases such as the diseases of heart, liver, kidney, hematopoietic system, digestive system and endocrine system should be cautious to use this equipment.

## 2.3 Technical specifications

Host	Power supply voltage: AC100-120V/200-240V
	Power supply frequency: 50/60Hz
	Input power: 150VA
	Dimension: 286mm×252mm×113mm
	Weight: 2.88Kg
Motor	Rotating speed range: 200~40000rpm
	Torque : 5-80Ncm (Speed ratio: 20:1)
	Input voltage: DC30V
	Dimension: $\phi$ 21.5mm×108mm
	Tail cord length: 1.8m
Foot pedal controller	Tail cord length: 2.0m

## 2.4 Intended use

This product is intended for use in dental surgery, thus other uses are not allowed.

## 2.5 Structure

The device is composed of main unit, motor with tube, handpiece, foot pedal and holder.

## 2.6 Safety requirements

we will not be responsible for any direct or indirect damages and losses under the following conditions:

- 1) The equipment is used for any purpose that is not mentioned in the scope of use.
- 2) The operator does not follow the steps and requirements in instruction manual to use the device.
- 3) Assemble, operate and repair the device without authorization of manufacturer.
- 4) The cabling system of the room where the device is used does not meet the appropriate standards and the appropriate requirements.
- 5) The environment in which the device is located or stored does not meet the requirements mentioned in technical requirements section of the instruction manual.

## 3 Configuration

### 3.1 The foot pedal structure description (Fig. 1)

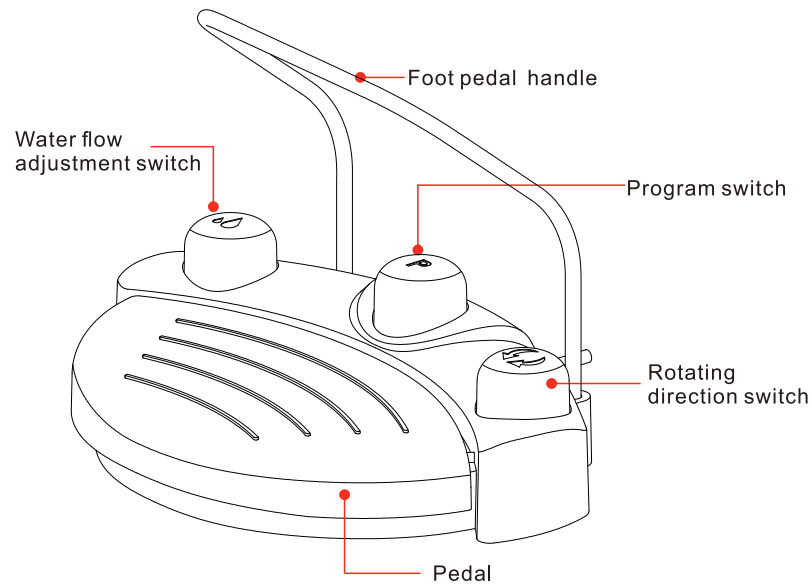

Fig. 1

### 3.2 The host structure description (fig. 2)

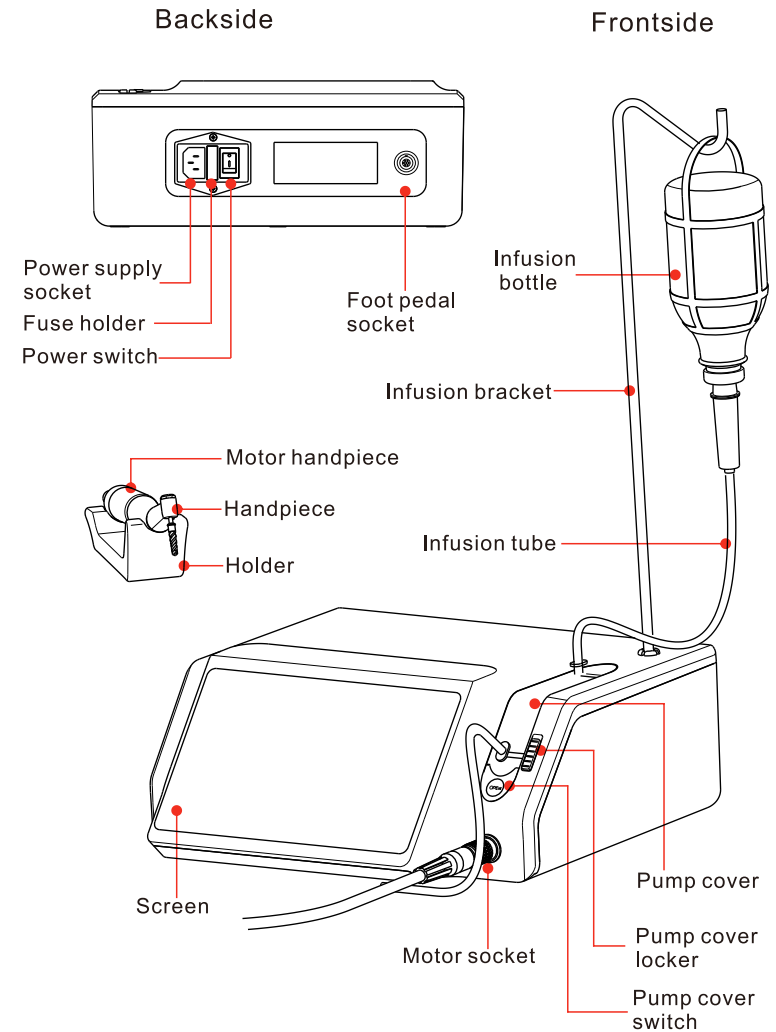

Fig. 2

### 3.3 The motor structure description (Fig. 3)

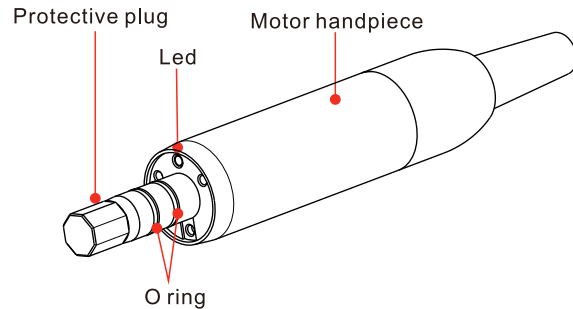

Fig. 3

## 4 Installation

### 4.1 Safety requirements during installation



#### Warnings

- 1) Equipment is installed on the premise that the installation must meet the appropriate standards and related electrical safety requirements.
- 2) Never install the device in an explosion-hazardous area and the device must not be operated in areas with flammable gases (anesthetic mixture, oxygen, etc.).
- 3) Installation site should be able to protect device from shocks and splashing of water or other liquids.
- 4) Do not install the device near or above a heat source. It must be installed in a well-ventilated area with sufficient space around it, especially the exhaust fan and back.



#### Dangers

- 1) Before connecting the cord to the device, make sure the joint is dry. If necessary, dry it with air gun.
- 2) Do not directly expose the parts to the sun or UV light source.
- 3) The device is movable. Be careful while handling it.

### 4.2 Accessories connection

8

#### 4.2.1 Installation of infusion bracket

Insert the infusion bracket into the fixing hole on the right rear of the shell, the locating pin match with the locating hole, there are four directions can adjust. (Fig. 4 A)

#### 4.2.2 Installation of infusion bottle

Hang the infusion bottle (The infusion bottle contains purchased normal saline injection.) on the bracket.

#### 4.2.3 Motor connection

Plug the tail cord of motor into the output socket on the front of the device (Note: align the red marking point). (Fig. 4B)

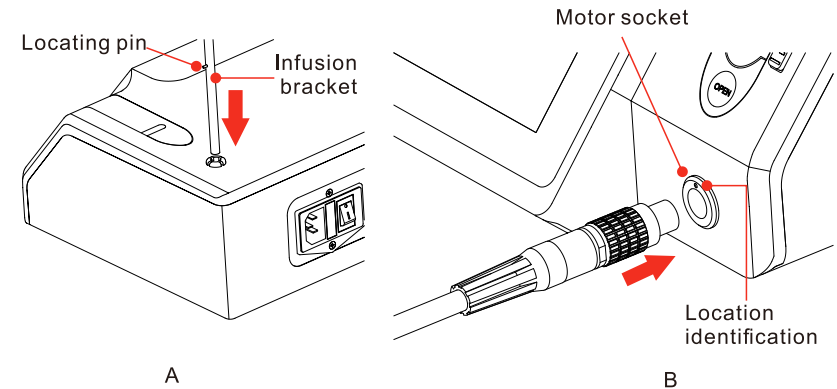

Fig. 4

#### 4.2.4 Installation of foot pedal

- 1) Connect the foot pedal handle to the foot pedal socket and tighten those two fixing screws. (Fig. 5A)
- 2) Connect the foot pedal plug to the host foot pedal socket and tighten those two fixing screws. (Fig. 5B)

#### 4.2.5 Power connection (Fig. 5B)

Plug the power cord output into the power supply socket of the device.

9

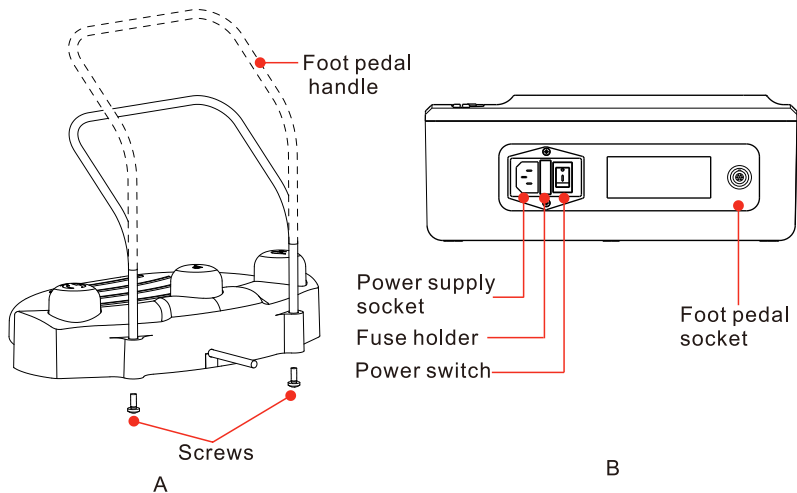

Fig. 5

### ⚠ Precautions

The power cable is damaged or no grounding cable may cause electric shock.

Check the power cable before use. Sockets must be equipped with protective contacts and comply with relevant national regulations.

The ground wire will be used as a functional earth (FE), not as a protective earth (PE).

#### 4.2.6 Handpiece connection( Fig. 6)

Connect the handpiece with the motor that must align the locating slot.

Turn the handpiece and check whether the handpiece is firmly attached to the motor.

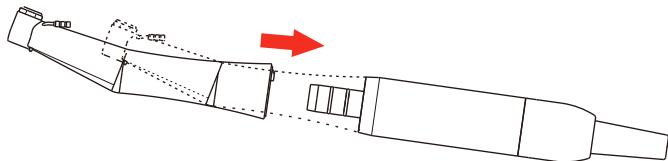

Fig. 6

### ⚠ Precautions

- 1) The motor and the handpiece will be severely worn if the handpiece is replaced or inserted during operation.
- 2) The handpiece should be replaced only when the motor is stopped.
- 3) The motor can be match with the handpiece in according to the ISO 3964.

#### 4.2.7 Handpiece disassembly

- 1) The handpiece should be replaced only when the motor is stopped

- 2) Pull the saline infusion tube out of the handpiece.

- 3) Pull out the handpiece gently.

#### 4.2.8 Peristaltic pump tube installation.

The infusion tube is installed on the pump cover.

- 1) Make sure the lock switch is in "🔒" .
- 2) Press the pump cover button to open the pump cover.
- 3) Install infusion tube in the direction shown.(Fig . 7A)
- 4) Press the pump cover.
- 5) Push the lock switch in the "🔒" direction.

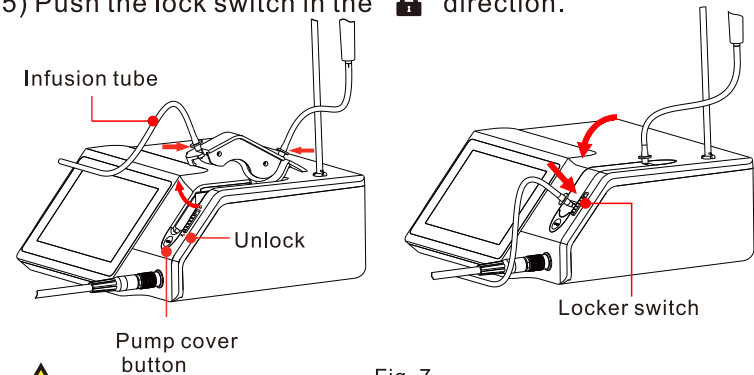

Fig. 7

### ⚠ Precautions

Use the same procedure to open the pump cover again and remove the infusion tube

When the pump cover is covered, the infusion tube shall not be squeezed or twisted, and keep relaxed and tension-free laid on the pump rotor.

The pump rollers may cause personal injury during operation. Shut off the equipment before opening the pump roller. Use the 1.5~2 liter saline container and check the stability of the device.

Sterilized infusion tube kit must be replaced after each use. Infusion tube kits must be checked before use to see if they are intact. If the product or package is damaged, the product must be disposed.

II The infusion tube connection with the handpiece.(Fig. 8)

- 1) Lay the infusion tube above the handpiece and connect it.
- 2) Place the infusion tube next to the motor cable. Do not wrap or bend it.

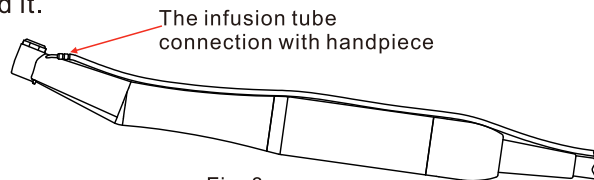

Fig. 8

### ! Precautions

After connecting the infusion tube to the handpiece, ensure that the infusion tube is not squeezed or bent. The infusion tube must be laid loose and tension-free.

## 5 Control interface of host and foot pedal

### 5.1 The host interface(Fig. 9)

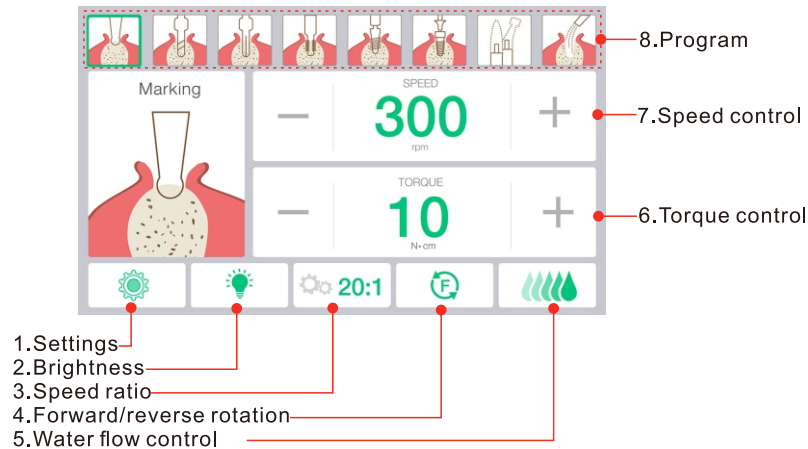

Fig. 9

### 5.2 Touch buttons instructions

#### 1) Touch buttons adjustments

Click the button to enter the parameter setting interface(Fig. 10)

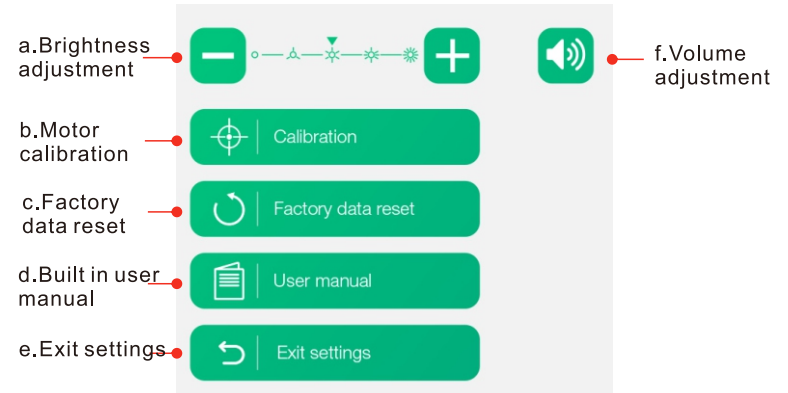

Fig. 10

#### a. Screen brightness adjustment

Click "+" or "-" can adjust the screen brightness.

#### b. Motor calibration

The motor calibration function is to compensate the torque deviation caused by replacing the handpiece or aging. This function is only effective for the 20:1 handpiece, otherwise it may cause inaccurate calibration.

Click the button, the motor starts, and the calibration process is automatically executed. During the calibration process, do not try to use the equipment. After the calibration, the interface prompts "Calibration is OK!" And automatically restores to standby state. If the calibration fails, the error code will be displayed. See Section 8: Error Alarm Interface for the solution of the corresponding error code.

If the screen and foot pedal functions fail during calibration, only be operated after calibration is completed.

#### c. Factory data reset

Click the button to restore the initial factory data.



d. Built in user manual

Click the button to read the built in user manual.

e. Exit settings

Click this button to exit the operation interface and return to the main interface.

f. Volume adjustment

Click the button to adjust the volume.

2) Motor LED brightness adjustment

Click the button to adjust motor LED brightness cyclically.

3) Speed ratio adjustment

Set the gear ratio to connect with the handpiece, which can be adjusted circularly.

4) Forward/reverse rotation setting

Set the motor rotating direction, which can be adjusted circularly.

5) Water flow adjustment

Set the water flow, there are 6 gears: no water in grade 1 (00%), 20% in grade 2, 40% in grade 3, 60% in grade 4, 80% in grade 5 and 100% in grade 6 (the maximum water yield is 125ml~135ml per minute, with slight differences between different tube).

Click the button each time, the gear increases by 1, which can be cyclically adjusted.

6) Torque adjustment

Click + or - to increase or reduce the torque, press for long time will accelerate the change.

7) Speed adjustment

Click + or - to increase or reduce the speed, press for long time will accelerate the change.

8) Program

The host has 8 program functions. Touch the corresponding icon and select the corresponding implant program. See Section 6.1 for detailed functions of each program.

**5.3 Foot pedal control** (Fig. 2)

1) Water flow button

It is used to select 6 gears of physiological saline flow size, and

one gear is added to the original gear each time pressed, which can be adjusted circularly.

2) Program switch

Used to select the implant program, the implant program will add one gear each time pressed, which can be adjusted circularly.

3) Forward/reverse rotation switch

The button is used to change the rotation direction of the handpiece, press the button to change the direction once, which can be adjusted cyclically.

4) Pedal

Used to start and stop the motor and control the motor speed during operation. The rotating speed of the motor is adjusted according to setting speed and the tread strength. When the pedal is released, the motor stops, and the interface displays the set value.

**6 Operation**

**6.1 Program**

6.1.1 Program selection

The host has 8 program functions, and there are two ways to select the program.

(1) Touch the corresponding icons on the screen.

(2) Tread the program switch button on the foot pedal.(Fig. 11)

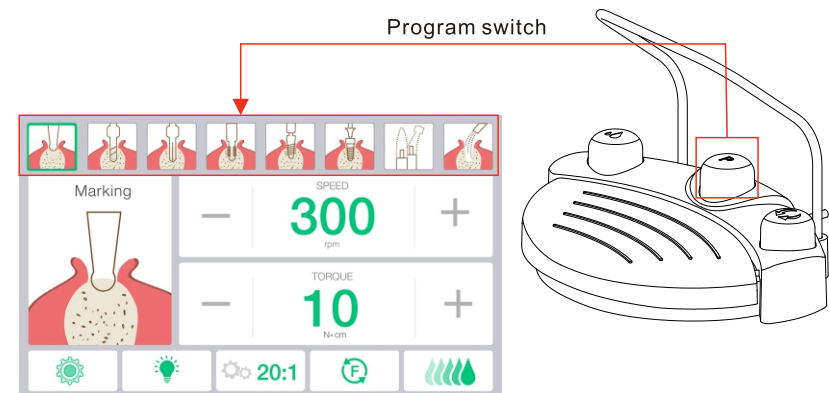
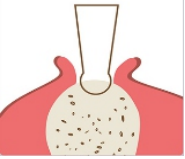

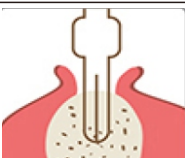
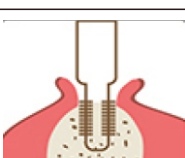
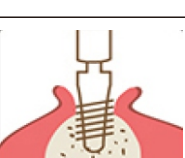
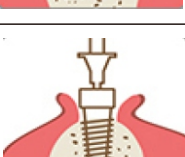
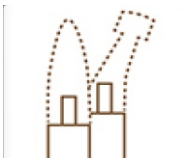
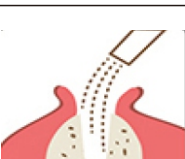

Fig. 11

### 6.1.2 Function description of programs

Icon	Function	Description
	Positioning	Accurate positioning on the alveolar bone by using a positioning drill.
	Hole-drilling	Determine the direction and depth of hole-drilling.
	Hole-broadening	Determine the diameter of the hole.
	Tapping	Make a thread on the hole to match the implant.
	Implanting	Implant dental implants into alveolar bone.
	Lock the abutment screw	Screw the nut onto the dental implant.

Icon	Function	Description
	User defined mode	Change straight handpiece, contra-angle with different speed ratios for different dental procedures.
	Cleaning	Water discharging without motor rotation is convenient for flushing.

### 6.1.3 User defined mode introduction

In the user defined mode, click the speed ratio icon at the bottom of the screen (the default speed ratio is 20:1), select the speed ratio according to the clinical requirements, and match with the corresponding handpiece.

<b>1:1</b>	<b>3.2:1</b>	<b>27:1</b>
<b>1:3</b>	<b>4:1</b>	<b>20:1</b>
<b>1:4.2</b>		<b>16:1</b>
<b>1:5</b>		



1:1, 1:3, 1:4.2 and 1:5 is applied to electric motor system which can be used for dental polishing, preparation, extraction and other treatment.

3.2:1 and 4:1 is applied to electric bone cutting system which can be used for oral surgery.

27:1, 20:1 and 16:1 is applied to implant system which can be used for implant surgery.

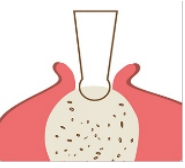
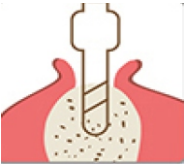
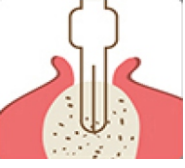
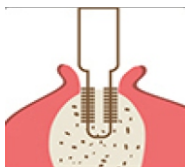
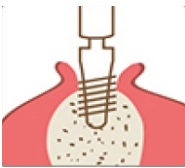
## 6.1.4 Factory Settings

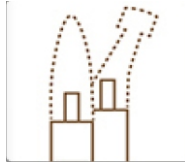
Icon	Function	Speed/ rpm	Torque/ N·cm	Speed ratio	Water flow/%
	Positioning	200-2500 1000(D)	5-60 35(D)	16:1 20:1(D) 27:1	40
	Hole- drilling	200-2500 800(D)	5-60 35(D)	16:1 20:1(D) 27:1	40
	Hole- broadening	200-2500 600(D)	5-60 35(D)	16:1 20:1(D) 27:1	40
	Taping	15-100 20(D)	5-80 35(D)	16:1 20:1(D) 27:1	40
	Implanting	15-100 20(D)	5-80 35(D)	16:1 20:1(D) 27:1	0

Icon	Function	Speed/ rpm	Torque/ N·cm	Speed ratio	Water flow/%
	Lock the abutment screw	15-100 20(D)	5-25 10(D)	16:1 20:1(D) 27:1	0
	User defined mode	15-40000 1000(D)	5-80 25(D)	16:1 20:1(D) 27:1	40
	Cleaning	-----	-----	-----	80

the letter “D” stands for factory setting value.

### 6.2 Factory settings adjustment

Within specified range, the adjustable parameters are as follow:

1. Maximum speed
2. Maximum torque
3. Water flow
4. Speed ratio

#### 6.2.1 Maximum speed adjustment

Touch the “Speed” (+, -) key to adjust motor speed. The speed will change each time after touching the “Speed” key. Long press the “Speed” key to accelerate the change of speed setting value.

#### 6.2.2 Maximum torque adjustment

Touch the “Torque” (+, -) key to adjust maximum torque output of motor. The torque will change each time after touching the

“Torque” key. Long press the “Torque” key to accelerate the change of torque setting value.

### 6.3 Water flow adjustment

- a. Touch the “Water flow” key on the screen to adjust. There are 6 water levels. The water level will change to the next level after each touch.
- b. Step on the green “Water flow adjustment” button to adjust water volume.

### 6.4 Motor rotation direction adjustment

- a. Touch the key to change the rotating direction of motor.
- b. Step on the “Forward/Reverse rotation” during operation to change the rotating direction of motor.

### 6.5 Standard operation

- 1) After installation of corresponding accessories, connect to the power supply, and turn on the power supply.
- 2) Touching screen or stepping on the “Program switch” button on the foot pedal to choose the program.
- 3) Confirm that the speed, torque, water flow, forward/reverse rotation, speed ratio and other parameters of corresponding program match the requirements.
- 4) Step on the foot pedal, and then motor starts to rotate. Deep step to accelerate; light step to reduce the speed; the maximum speed value is the current program speed setting value. After fully release, the motor stops rotating, and the interface displays the speed set value.
- 5) Torque protection will start as the torque reaches preset value. Meanwhile, the motor slows down to stop, preventing from generating excessive torque. Release foot pedal to remove torque protection. Step again, and the motor will rotate under preset torque value.
- 6) Release the foot pedal, the motor stop rotating, interface displays set value, and can adjust each parameter.

## 7 Clean, disinfection, and sterilization

If there is blood or salt residue on the main unit and foot pedal, unplug the power cord, wipe it off with a damp cloth, and wipe with  
20

a soft cloth dampened with alcohol. Handpiece can be disinfected with heat sterilizers!

Before the first use, it is recommended to let it be autoclaved under 135 °C and (0.20 ~ 0.23) MPa for not less than 4 minutes.



### Precautions

Only the handpiece and holder can be sterilized.

#### 7.1 Cleaning

Thoroughly wipe all visible surfaces of the device with a disposable soft cloth, including infusion bracket, foot pedal, cables and so on.

#### 7.2 Disinfection

Wiping all visible surfaces of the device including infusion bracket, foot pedal and cables with a disposable soft cloth dampened with disinfectant, and ensure that all surfaces are wet.

#### 7.3 Drying

Dry all the cleaned and disinfected parts thoroughly in the air indoors .

Disposable infusion tubes are for single use only which should not be disinfected and sterilized, and have no need of drying.

#### 7.4 Packaging

Seal the handpiece and holder in the sterilization bag.

#### 7.5 Sterilization







Put the sterilization bags into the autoclave sterilizer. It is recommended to be sterilized under 135 °C (273 F), (0.2-0.23) Mpa for not less than 4 minutes. Dry them after sterilization.





### Precautions

The main unit, motor handpiece, foot pedal and power cord cannot be antoclaved.

## 8 Error code and solution

Error interface	Error description	Solution
 <p><b>Malfunction</b> <b>Peristaltic Pump abnormal</b></p> <p>Possible causes: -Improper installation of peristaltic pump flexible pipe -The pump cover is not closed properly</p> <p>Remedy: Check the pump flexible pipe, close the pump cover</p>	<p>Peristaltic pump abnormality</p> <ol style="list-style-type: none"> <li>1. The infusion tube is not pressed in place or biased.</li> <li>2. The pump cover is not fastened properly.</li> </ol>	<ol style="list-style-type: none"> <li>1. Check pump tube for reinstallation.</li> <li>2. Refasten the pump cover.</li> </ol>
 <p><b>Malfunction:</b> <b>Reach set torque</b></p> <p>Possible causes: -Torque setting too small -Transmission ratio setting error</p> <p>Remedy: Release the pedal. Check the transmission ratio. Increase the set torque value.</p>	<p>Torque set value is too low.</p>	<p>Increase the set torque value.</p>
 <p><b>Malfunction:</b> <b>Calibration failed</b></p> <p>Possible causes: -Circuit failure -Motor bending head not empty</p> <p>Remedy: Check whether the motor bending head is empty. Recalibrate.</p>	<p>Calibration failure.</p>	<p>Reconnect the handpiece and calibrate again.</p>
 <p><b>Malfunction:</b> <b>Pedal not connected</b></p> <p>Possible causes: -Broken pedal line -Pedal switch not inserted</p> <p>Remedy: Check pedal switch, Re-plug the pedal switch, reset machine.</p>	<p>The foot pedal is not fully connected to the main unit.</p>	<p>Reconnect the foot pedal, and restart the unit after power off for 10 seconds.</p>
 <p><b>Malfunction:</b> <b>Motor abnormal</b></p> <p>Possible causes: -The motor current is too high -Motor overheating</p> <p>Remedy: Wait for the motor to cool before use.</p>	<p>Motor is worked for a long time, resulting in high temperature.</p>	<p>Stop the motor for a period of time, wait for the motor cools before operation.</p>
 <p><b>Malfunction:</b> <b>Motor LED abnormal</b></p> <p>Possible causes: -Motor LED breakdown -The motor light wire is disconnected.</p> <p>Remedy: Replace the motor.</p>	<p>LED abnormal.</p>	<p>Replace the motor.</p>

Error interface	Error description	Solution
 <p><b>Malfunction:</b> <b>Abnormal main board voltage</b></p> <p>Possible causes: -Main board breakdown</p> <p>Remedy: contact the manufacturer for repair.</p>	<p>The main board voltage is abnormal.</p>	<p>Please contact local distributors or manufacturer.</p>
 <p><b>Malfunction:</b> <b>Peristaltic pump voltage abnormal</b></p> <p>Possible causes: -The main board is damaged.</p> <p>Remedy: Contact the manufacturer for repair.</p>	<p>Peristaltic pump failure: The main board may be damaged.</p>	<p>Please contact local distributors or manufacturer.</p>
 <p><b>Malfunction:</b> <b>Abnormal motor voltage</b></p> <p>Possible causes: -The switching power supply is damaged</p> <p>Remedy: contact the manufacturer for repair.</p>	<p>Motor voltage abnormality.</p>	<p>Switch power supply damage, Please contact local distributors or manufacturer.</p>

## 9 Storage, maintenance and Transportation

### 9.1 Storage

- 1) The device should be handled carefully and lightly. Be sure that it is far from the vibration, and installed or kept in a cool, dry, and ventilated place.
- 2) Do not store the device together with articles that is poisonous, combustible, caustic, or explosive.
- 3) This device should be stored in a room where the relative humidity is 10%~85%, atmospheric pressure is 70kPa~106kPa, and the temperature is -20°C ~ +55°C.
- 4) Turned off power switch and unplug the power plug when the device is not in use. If it is not used for a long time, please get through to power supply and water for five minutes once per month.
- 5) Check the integrity of cable. If it is damaged, please replace it with original accessories.

## 9.2 Maintenance

The device does not contain any parts that can be repaired by users. Maintenance of the device should only be carried out by professionally trained service personnel.

## 9.3 Transportation

During transportation, avoid excessive impact and vibration, handle with care, keep away from dangerous goods, and avoid sun and rain.

## 9.4 Replacement of fuse

Power supply shall be cut off while intending to conduct the following operations. And disconnect power supply cable and main power supply.(Fig. 12)

- 1) Insert a flat-blade screwdriver to the groove under the power supply hole, and then pry it out.
- 2) Pull out the fuse compartment and select the appropriate fuse for replacement by following the label on the bottom of the power supply socket.
- 3) Push the fuse compartment to the initial position.

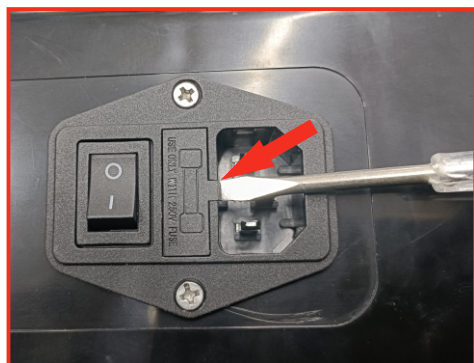













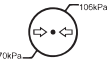
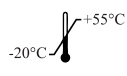



Fig. 12

## 10 Environment protection

The device does not contain any harmful ingredients, please follow the local waste disposal policy to dispose.

## 11 Standard symbols

OFF/ON	Power switch		Use indoor only
	Date of manufacture		Manufacturer
	Serial number		Attention! Look up random files
	Recycle		Type B applied part
	Alternating current		Fuse
	Fragile		Storage humidity does not exceed 85%RH
	Foot pedal switch socket		Protective earthing
<b>IPXI</b>	Drip-proof	<b>IPX6</b>	Strong water spraying experiment
	Storage pressure 70kPa ~ 106kPa		Storage temperature at -20°C ~ +55°C
	Deal with the product according to the WEEE (2002/96/EC)		

## 12 Statements

We reserves the right to change the design of the equipment, the technique, accessories, instruction manual and the content of the original packing list at any time without further notice. The pictures are only for reference.

UM-IM-M20230801-Ver1.1

<https://www.kadashika.jp>